

# CHAPTER 4. PARTS CATALOG

## CONTENTS

PowerShot A200/PowerShot A100	
Casing Parts -----	Pg1
Internal Parts -----	Pg2
Accessories-1 -----	Pg3
Accessories-2 -----	Pg4
Accessories-3 -----	Pg5
Service Tools-----	Pg6

### CLASS凡例

- A: 使用頻度 高
- B: 使用頻度 中
- C: 使用頻度 低
- D: 安全規格部品
- E: 消耗部品
- F: 標準ネジ、ワッシャー
- S: 供給制限品

### Category of CLASS

- A: Frequency of use: High
- B: Frequency of use: Middle
- C: Frequency of use: Low
- D: Safety-related critical parts
- E: Consumable parts
- F: Standard screws and washers
- S: Supply of the parts is limited

# Casing Parts

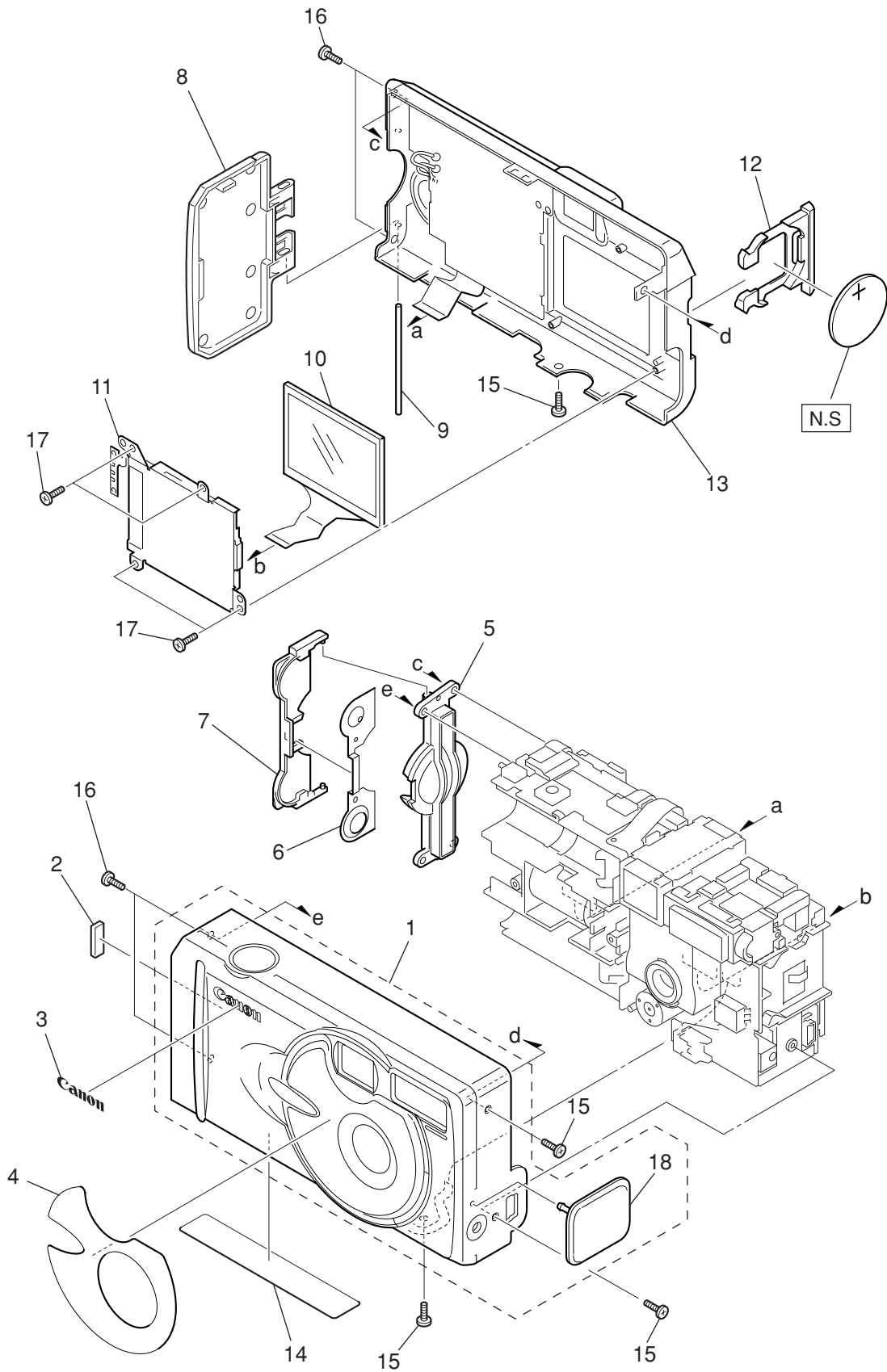

# PARTS LIST

SYMBOL	PARTS NO.	CLASS	QTY	DESCRIPTION	REMARKS
1	CM1-1307-000	B	1	FRONT COVER UNIT	A100
	CM1-1440-000	B	1	FRONT COVER UNIT	A200
2	CD1-4159-000	B	1	CUSHION, BATTERY COVER	
3	CB1-8303-000	B	1	PLATE, LOGO	
4	CD1-4324-000	B	1	PANEL, BARRIER	
5	CD1-4126-000	B	1	COVER, CF	
6	CD1-4121-000	C	1	PLATE, BATTERY CONTACT	
7	CD1-4124-000	B	1	COVER, BATTERY	
8	CD1-4127-000	B	1	COVER, SIDE	
9	CD1-4128-000	C	1	BAR, BATTERY COVER	
10	CK5-0051-000	C	1	PANEL, LCD	
	CK5-0051-001	C	1	PANEL, LCD (SELECTION)	
11	CM1-1310-000	C	1	BACK LIGHT UNIT	
12	CD1-4138-000	B	1	HOLDER, LITHIUM BATTERY	
13	CM1-1308-000	B	1	REAR COVER UNIT	
14	CY1-6158-000	B	1	PLATE, BODY NUMBER (J)	A100
	CY1-6181-000	B	1	PLATE, BODY NUMBER (J)	A200
	CY1-6159-000	B	1	PLATE, BODY NUMBER (N)	A100
	CY1-6182-000	B	1	PLATE, BODY NUMBER (N)	A200
	CY1-6160-000	B	1	PLATE, BODY NUMBER (E)	A100
	CY1-6183-000	B	1	PLATE, BODY NUMBER (E)	A200
	CY1-6161-000	B	1	PLATE, BODY NUMBER (O)	A100
	CY1-6184-000	B	1	PLATE, BODY NUMBER (O)	A200
15	CD1-4157-000	F	4	SCREW	
16	XA4-9170-557	F	4	SCREW	
17	XA4-9170-407	F	4	SCREW	
18	CD1-4118-000	B	1	COVER, CONNECTOR	

# Internal Parts

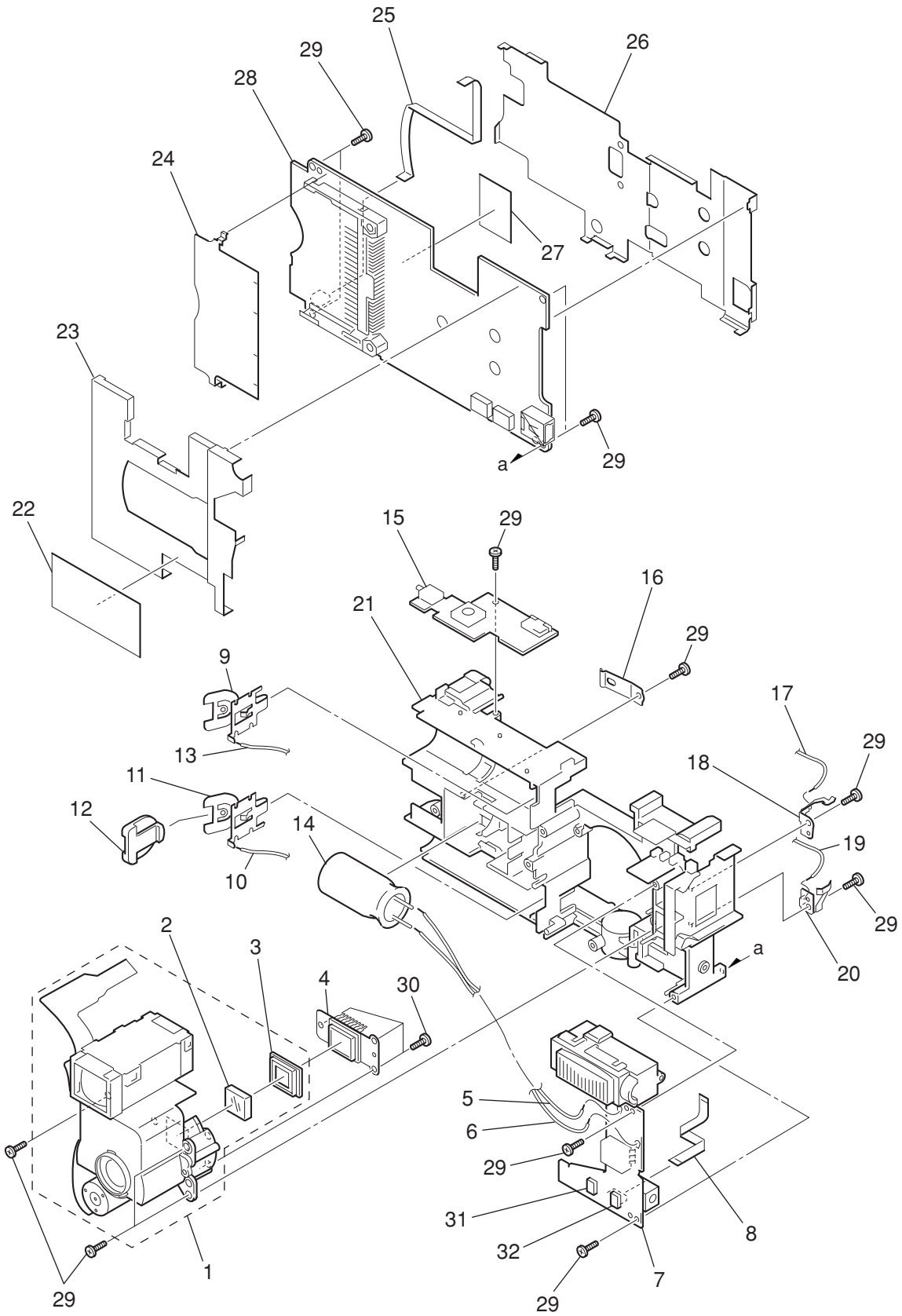

# PARTS LIST

SYMBOL	PARTS NO.	CLASS	QTY	DESCRIPTION	REMARKS
1	CY1-6156-000	B	1	OPTICAL UNIT	
2	YN1-1936-000	C	1	FILTER, IR	A100
	YN1-1937-000	C	1	FILTER, IR	A200
3	CD1-4087-000	C	1	RUBBER, CCD	
4	CY1-6157-000	C	1	CCD UNIT	A100
	CY1-6180-000	C	1	CCD UNIT	A200
5	CK2-1269-000	C	1	LEAD, MICROPHONE (-)	
6	CK2-1268-000	C	1	LEAD, MICROPHONE (+)	
7	CM1-1305-000	C	1	FLASH UNIT	
8	CK2-1270-000	C	1	FPC, M-S	
9	CD1-4120-000	C	1	CONTACT, BATTERY (-)	
10	CK2-1271-000	C	1	LEAD, BATTERY (+)	
11	CD1-4119-000	C	1	CONTACT, BATTERY (+)	
12	CD1-4122-000	C	1	GUARD, BATTERY (+)	
13	CK2-1272-000	C	1	LEAD, BATTERY (-)	
14	CK9-0402-000	C	1	CAPASITOR, ELECT., 80MF/330V	
15	CM1-1302-000	C	1	PCB ASS'Y, RLS	
16	CD1-4125-000	C	1	PLATE, BATTERY LOCK	
17	CK2-1290-000	C	1	LEAD, LITHIUM (+)	
18	CD1-4139-000	C	1	CONTACT, LITHIUM (+)	
19	CK2-1291-000	C	1	LEAD, LITHIUM (-)	
20	CD1-4140-000	C	1	CONTACT, LITHIUM (-)	
21	CD1-4113-000	C	1	FRAME, MAIN	
22	CD1-4418-000	C	1	SHEET, EM 1	
23	CD1-4141-000	C	1	CASE, MAIN SHIELD 1	
24	CD1-4143-000	C	1	CASE, MAIN SHIELD 3	
25	CK2-1257-000	C	1	FPC, M-R	
26	CD1-4142-000	C	1	CASE, MAIN SHIELD 2	
27	CD1-4419-000	C	1	SHEET, EM 2	
28	CM1-1301-000	C	1	PCB ASS'Y, MAIN	A100
	CM1-1439-000	C	1	PCB ASS'Y, MAIN	A200
29	XA4-9170-407	F	13	SCREW	
30	XA4-9140-307	F	3	SCREW	
31	CK9-0416-000	C	1	FUSE, SKK UMF 2012	
32	CK9-0415-000	C	1	FUSE, SKK I14	

## Accessories-1

**Wrist Strap WS-200**

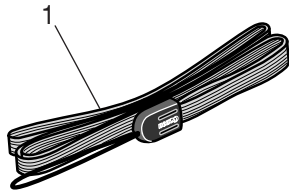

**USB Interface Cable  
IFC-300PCU**

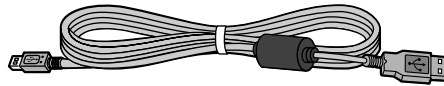

**CF Card FC-8M**

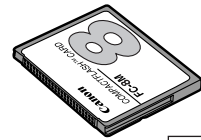

**Canon Digital Camera  
Solution Disk**

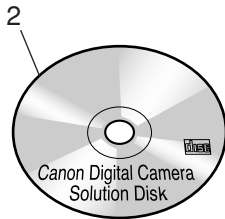

**AC Cable**

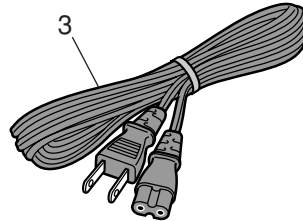

**Alkaline Batteries (X2)**



**N.S.**: N.S Stand for No Stock (Product available)

# PARTS LIST

SYMBOL	PARTS NO.	CLASS	QTY	DESCRIPTION	REMARKS
1	C84-1060-000	B	1	WRIST STRAP WS-200	
2	C84-1115-000	S	1	CD-ROM, SOLUTION DISK VER.9.0 (J/E) PS A100	FOR JAPAN, ASIA, AUSTRALIA
	C84-1116-000	S	1	CD-ROM, SOLUTION DISK VER.9.0 (J/E) PS A100	FOR USA, CANADA
	C84-1117-000	S	1	CD-ROM, SOLUTION DISK VER.10.0 (J/E) PS A200	FOR JAPAN, ASIA, AUSTRALIA
	C84-1118-000	S	1	CD-ROM, SOLUTION DISK VER.10.0 (E/F/S) PS A200	FOR USA, CANADA
3	WT3-5062-000	C	1	AC CABLE (J)	FOR JAPAN
	WT3-5063-000	C	1	AC CABLE (N)	FOR USA, CANADA
	WT3-5064-000	C	1	AC CABLE (E)	FOR EUROPE, ASIA
	WT3-5115-000	C	1	AC CABLE (B)	FOR USA
	WT3-5066-000	C	1	AC CABLE (A)	FOR AUSTRALIA

## Accessories-2

### Water proof Case WP-DC400

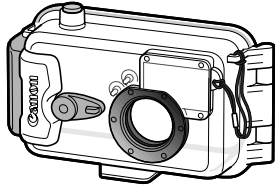

N.S

### Water proof Seal

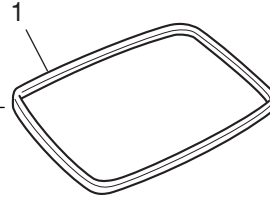

### Grease Packing

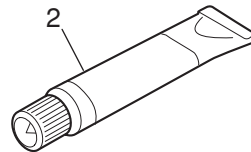

### Protector Moisture

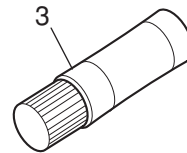

### Neck Strap

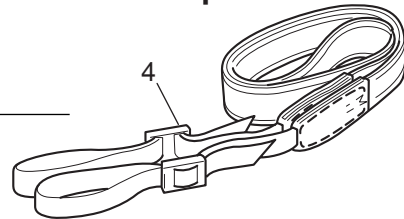

### Wrist Strap

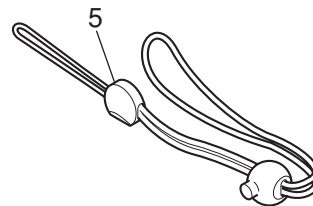

### Diffusion Plate Unit

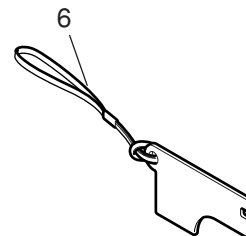

**N.S**: N.S Stand for No Stock (Product available)

# PARTS LIST

SYMBOL	PARTS NO.	CLASS	QTY	DESCRIPTION	REMARKS
1	CY1-6175-000	B	1	PACKING, RUBBER, WP-DC400	
2	DY9-3029-000	C	1	GREASE, PACKING	
3	DY9-3028-000	C	1	PROTECTOR, MOISTURE	
4	CY1-6099-000	B	1	NECK STRAP	
5	CY1-6174-000	B	1	WRIST STRAP	
6	CY1-6176-000	B	1	DIFFUSION PLATE UNIT	

## Accessories-3

### Camera User Guide

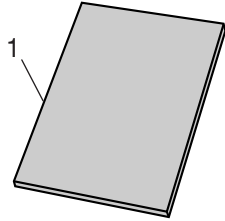

### Software Starter Guide

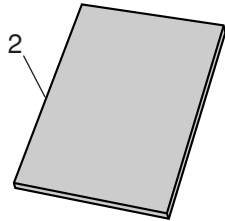

### System Map

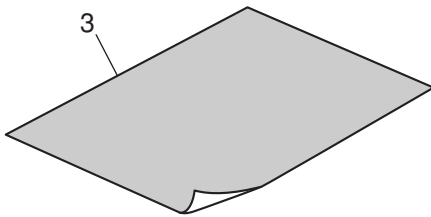

# PARTS LIST

SYMBOL	PARTS NO.	CLASS	QTY	DESCRIPTION	REMARKS	
1	CDI-J036-000	S	1	I.BOOK (J) PS A100	FOR JAPAN	
	CDI-E037-000	S	1	I.BOOK (E) PS A100	FOR USA, CANADA, ASIA, AUSTRALIA	
	CDI-F027-000	S	1	I.BOOK (F) PS A100	FOR CANADA	
	CDI-S034-000	S	1	I.BOOK (S) PS A100	FOR USA	
	CDI-J038-000	S	1	I.BOOK (J) PS A200	FOR JAPAN	
	CDI-E039-000	S	1	I.BOOK (E) PS A200	FOR USA, CANADA, ASIA, AUSTRALIA	
	CDI-F029-000	S	1	I.BOOK (F) PS A200	FOR CANADA	
	CDI-S036-000	S	1	I.BOOK (S) PS A200	FOR USA	
	2	CDI-J035-000	S	1	SOFTWARE GUIDE (J) PS A100	FOR JAPAN
		CDI-E045-000	S	1	SOFTWARE GUIDE (E) PS A100	FOR USA, CANADA, ASIA, AUSTRALIA
		CDI-F035-000	S	1	SOFTWARE GUIDE (F) PS A100	FOR CANADA
		CDI-S032-000	S	1	SOFTWARE GUIDE (S) PS A100	FOR USA
CDI-J042-000		S	1	SOFTWARE GUIDE (J) PS A200	FOR JAPAN	
CDI-E046-000		S	1	SOFTWARE GUIDE (E) PS A200	FOR USA, CANADA, ASIA, AUSTRALIA	
CDI-F036-000		S	1	SOFTWARE GUIDE (F) PS A200	FOR CANADA	
CDI-S033-000		S	1	SOFTWARE GUIDE (S) PS A200	FOR USA	
3		CDI-J037-000	S	1	SYSTEM MAP (J) PS A100	FOR JAPAN
		CDI-E038-000	S	1	SYSTEM MAP (E) PS A100	FOR USA, CANADA, ASIA, AUSTRALIA
		CDI-F028-000	S	1	SYSTEM MAP (F) PS A100	FOR CANADA
		CDI-S035-000	S	1	SYSTEM MAP (S) PS A100	FOR USA
	CDI-J039-000	S	1	SYSTEM MAP (J) PS A200	FOR JAPAN	
	CDI-E040-000	S	1	SYSTEM MAP (E) PS A200	FOR USA, CANADA, ASIA, AUSTRALIA	
	CDI-F030-000	S	1	SYSTEM MAP (F) PS A200	FOR CANADA	
	CDI-S037-000	S	1	SYSTEM MAP (S) PS A200	FOR USA	

## Service Tools

**DIA BOND NO.1663G BLACK**

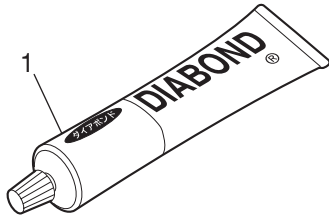

**W-10 Filter**

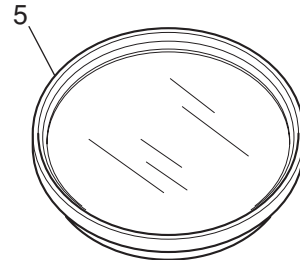

**Adhesive Tape SONY T4000**

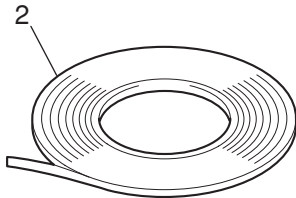

**18% Gray Chart**

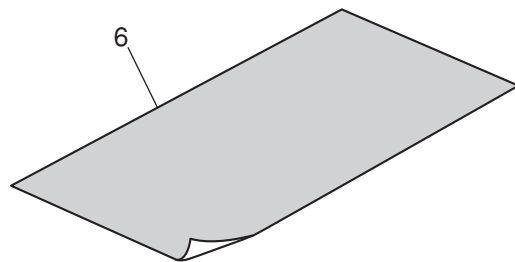

**Adhesive Tape 3M NO.56**

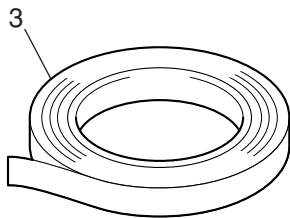

**SERVICE MANUAL CD-ROM**

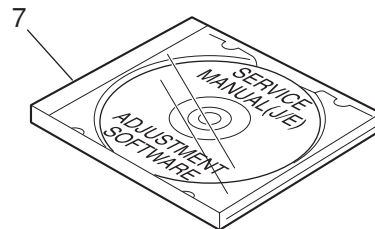

**C-12 Filter**

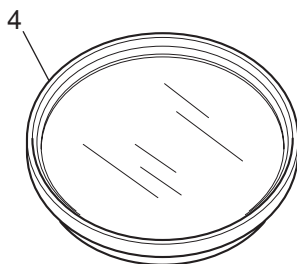

# PARTS LIST

SYMBOL	PARTS NO.	CLASS	QTY	DESCRIPTION	REMARKS
1	CY9-8129-000	Y	1	BOND, DIA BOND NO.1663G BLACK	
2	CY9-6012-000	Y	1	ADHESIVE TAPE, SONY T4000	6mm X 50m roll
3	CY4-6018-000	Y	1	ADHESIVE TAPE, 3M NO.56	15mm X 66m roll
4	DY9-2029-000	Y	1	FILTER, C-12	
5	CY9-1543-000	Y	1	FILTER, W-10	
6	CY4-6016-000	Y	1	CHART, 18% GRAY	
7	CY8-4377-031	Y	1	CD-ROM, SERVICE MANUAL (J/E)	